

VIEW R
APC100 WIRING

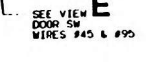

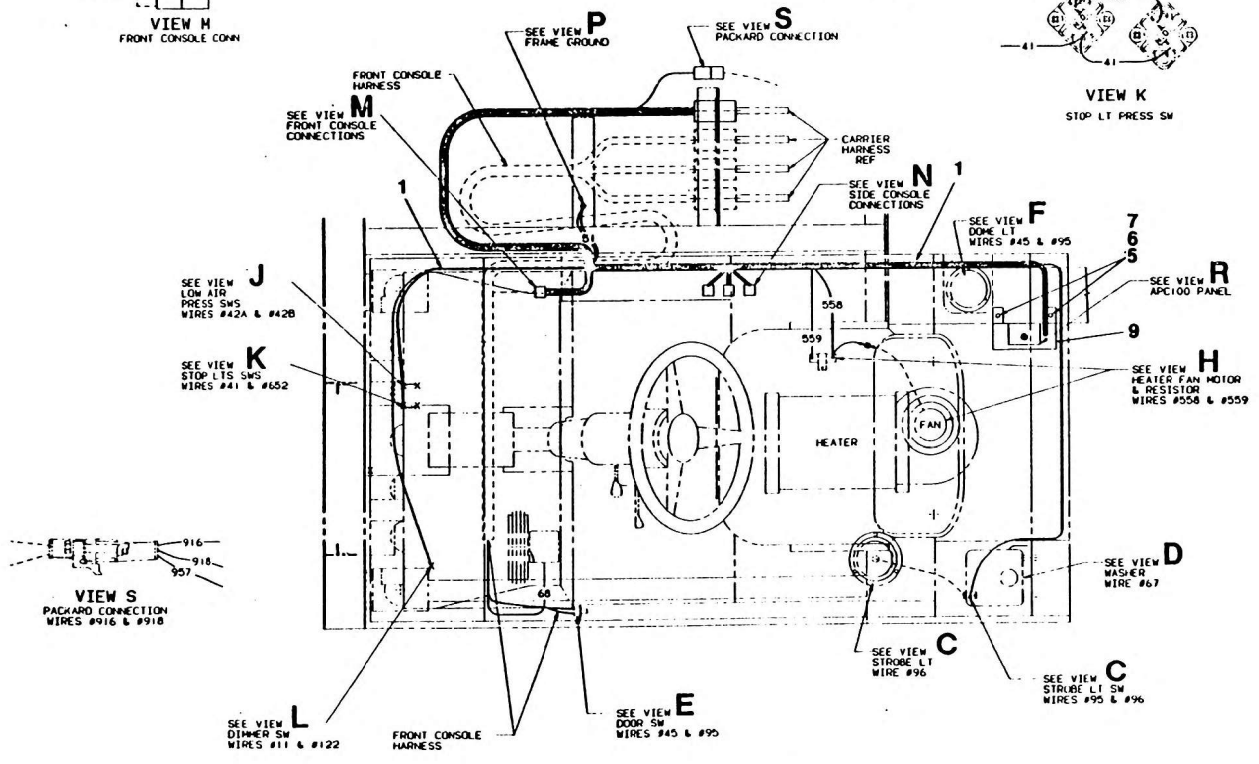

2 STAMP WIRE #96 ON A PIECE OF ITEM #4. REMOVE A PORTION OF THE INSULATION WITH THE WIRE NUMBER ON IT & SLIDE IT ON THE WIRE WHERE INDICATED.

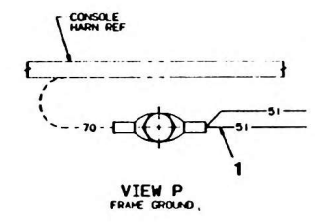
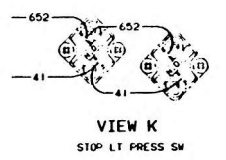
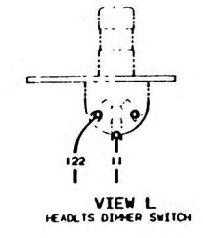
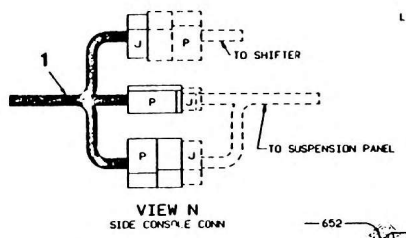
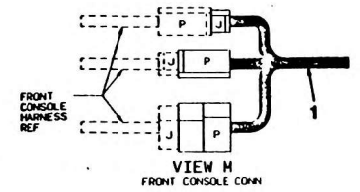
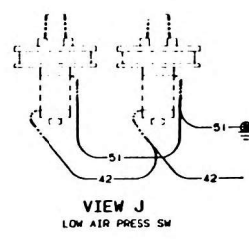
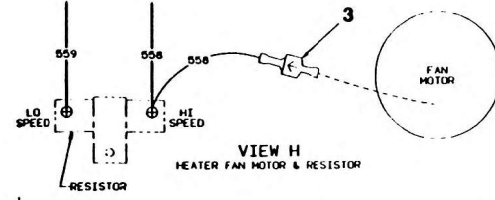
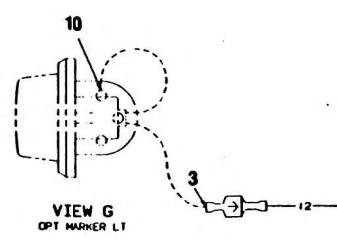
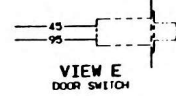
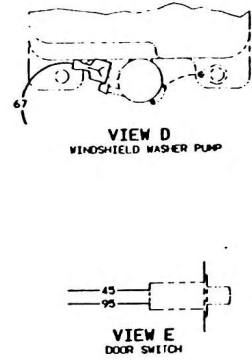
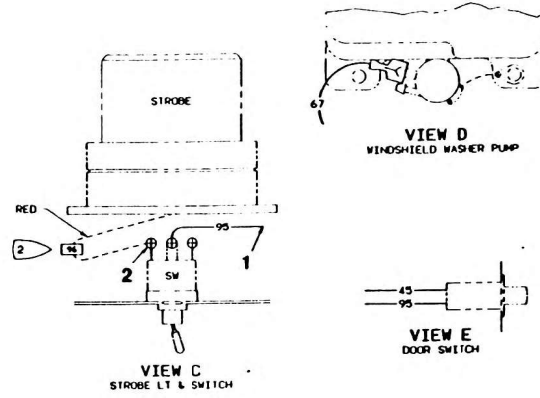
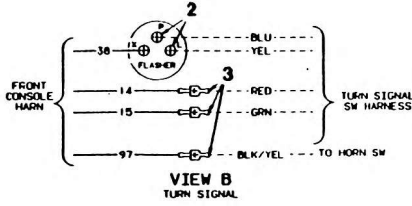
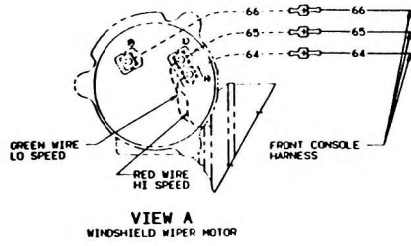